



 2+ |
  4 |
  1m |
  1 = 1,2m 2 = 1,2m 3 = 0,9m

 Motor disability
 Sensorial disabilities
 Learning disabilities



Play value : 3

balancing

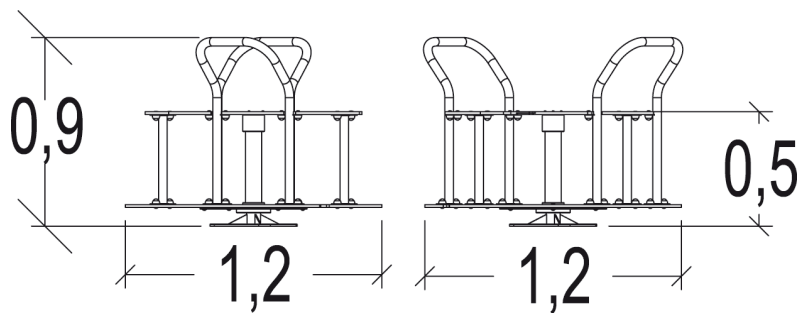
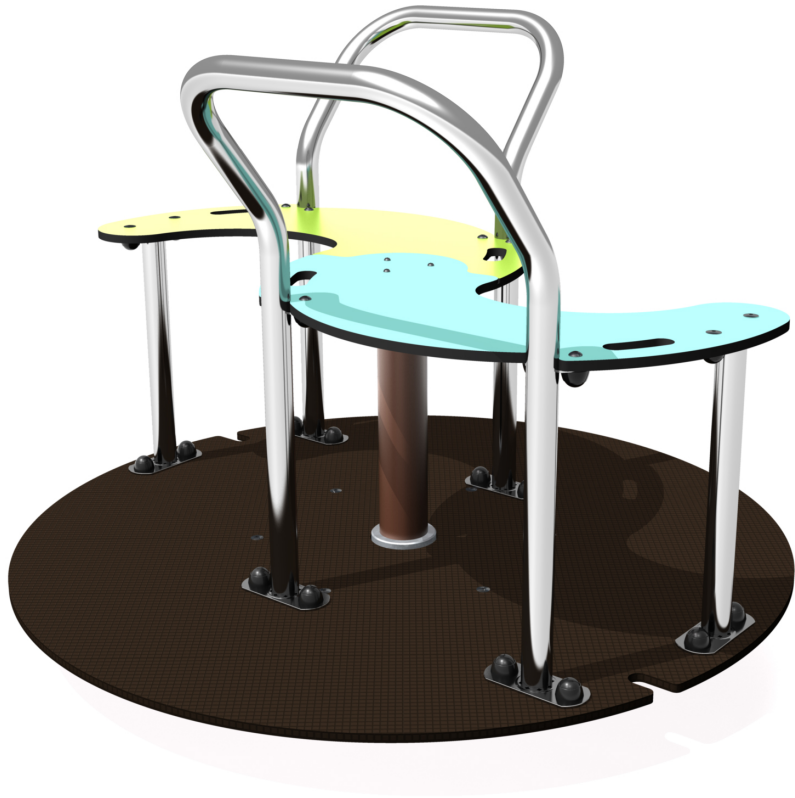

meeting / role play



rotating



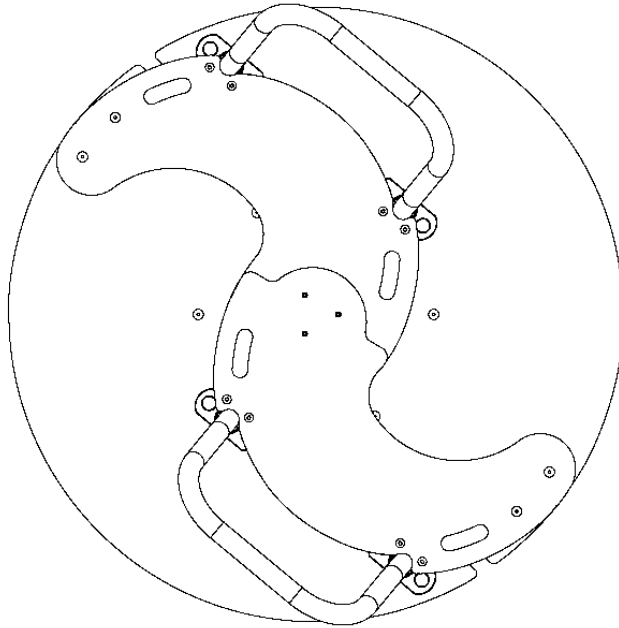







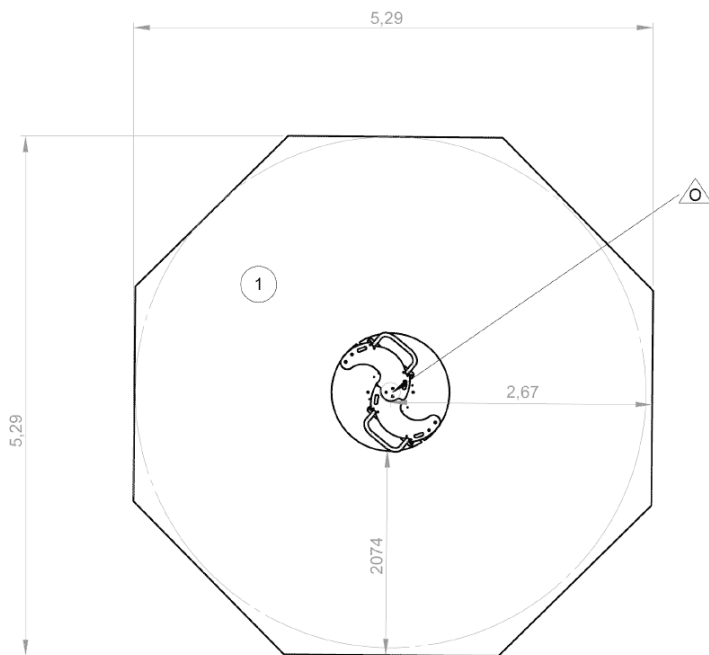



Installation of equipment

Impact area =

-  Impact area
-  Free space

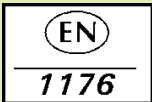

	
1	1m
	23m ²

							
1	03h00	0.3m ³	23m ²	95kg	84kg		2015-07-31